

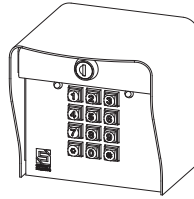

**1** Unpack box and make sure you have everything shown here.



Keypad Unit



Key



Carriage Bolt  
( 4x )



Hex Nut  
( 4x )

**2** Unlock and open faceplate of keypad unit; then using included carriage bolts and hex nuts, attach unit to pedestal as shown.

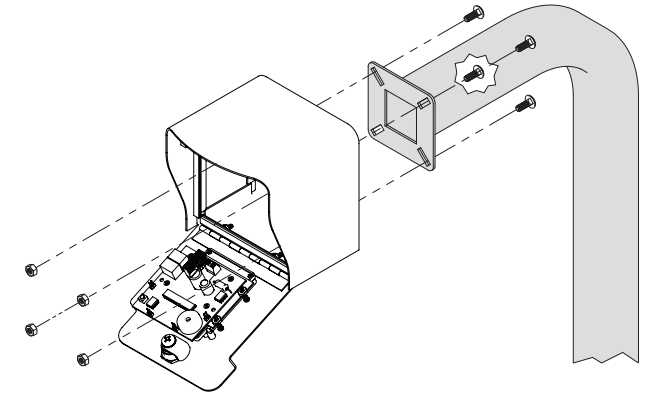

## What's what?

Important components labeled

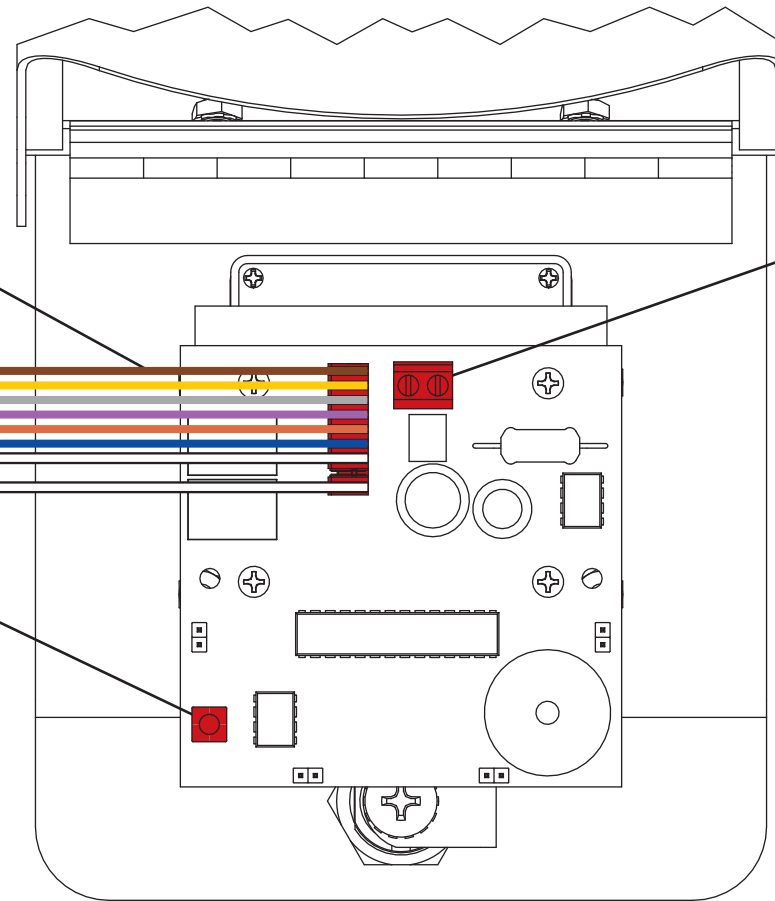

**Wire Harness**

For wiring to gate operator or door opener, accessories, and power

**Reset Button**

For performing reset procedures

Unit shown with faceplate fully open.

**Event Input Terminals**

For wiring to an exit device or magnetic contact

**Keypad Unit Faceplate**

Continued on next page...

**! WARNING !**

**AUTOMATIC GATES CAN CAUSE SERIOUS INJURY OR DEATH!**

**ALWAYS CHECK THAT THE GATE PATH IS CLEAR BEFORE OPERATING!**

**REVERSING OR OTHER SAFETY DEVICES SHOULD ALWAYS BE USED!**

# INSTALL GUIDE | ADVANTAGE DK

Model ADV-1000

## 3a Connect wires.

Wiring for Gate Operator or Door Opener

### Gate Operator / Door Opener

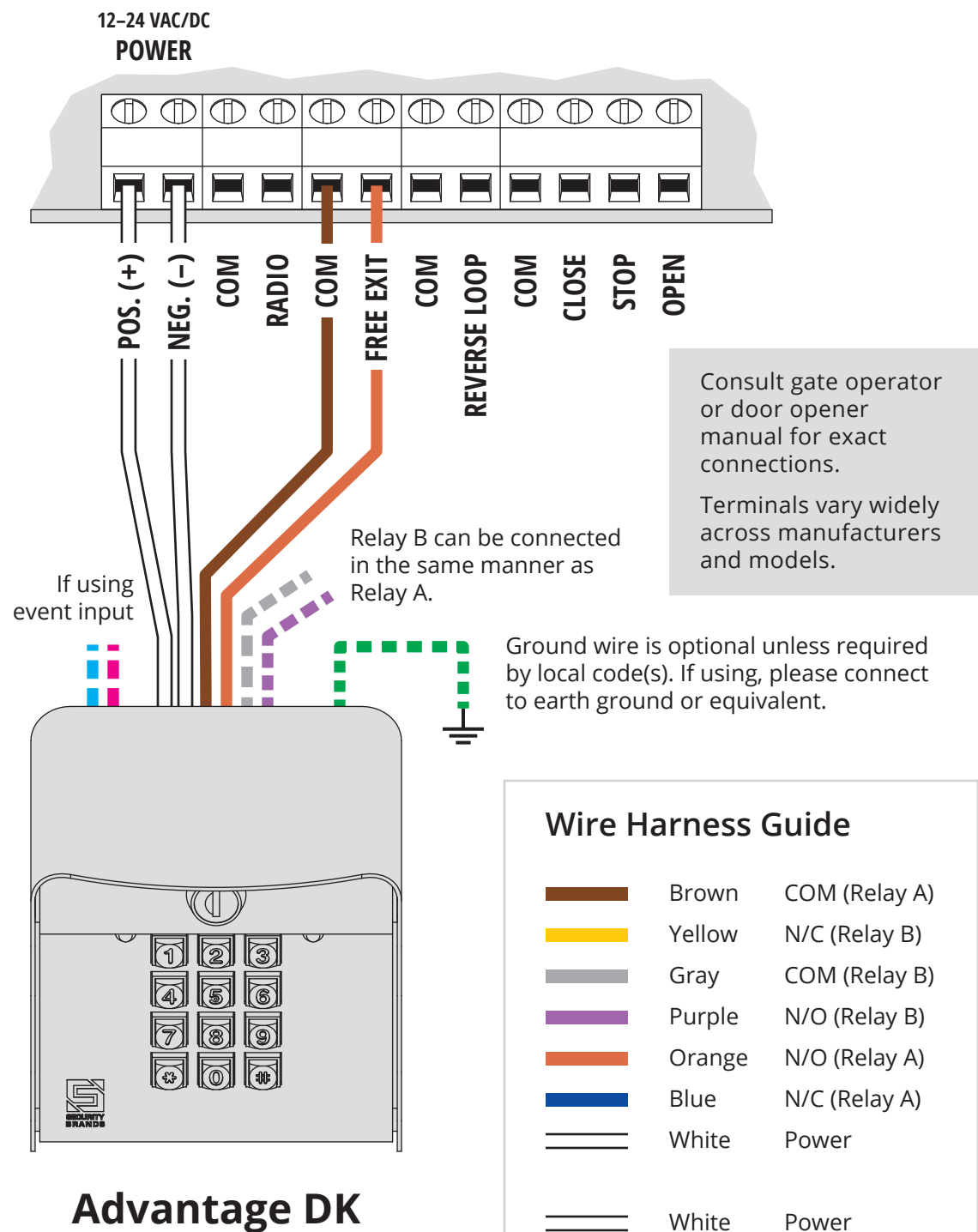

## 3b Connect wires.

Wiring for Electric Door Strike and Exit Device

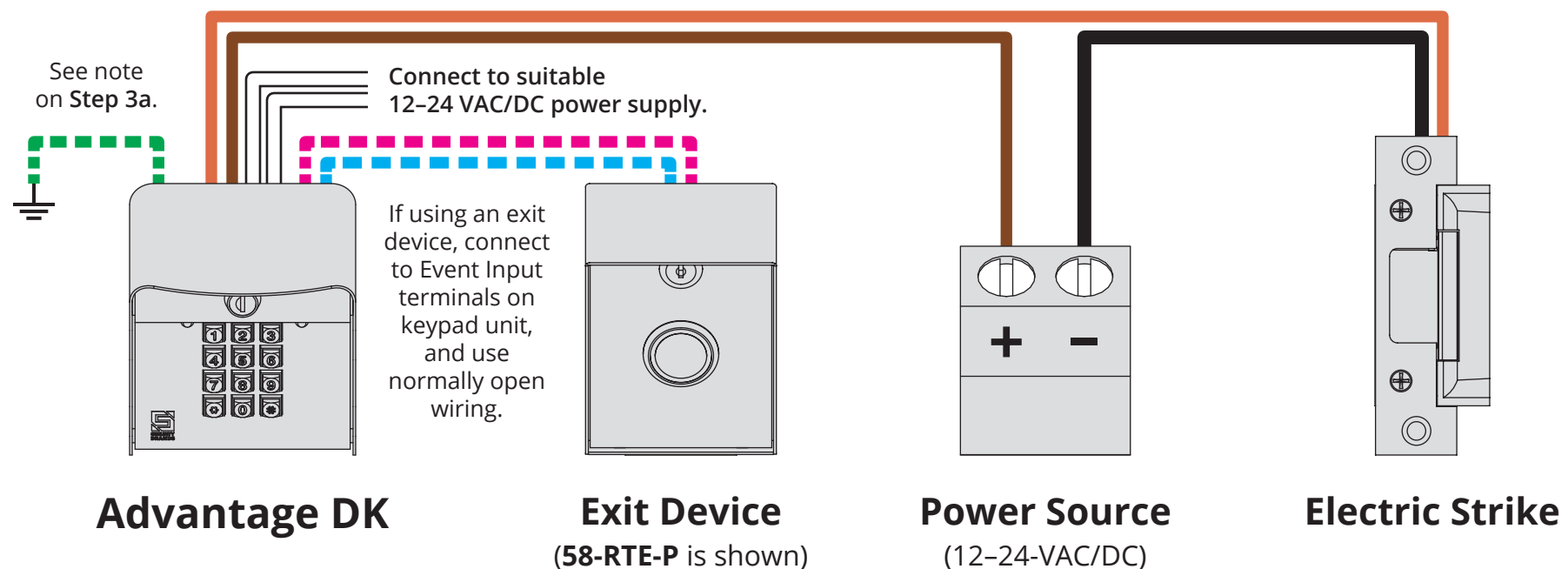

## 3c Connect wires.

Wiring for Mag Lock and Exit Device

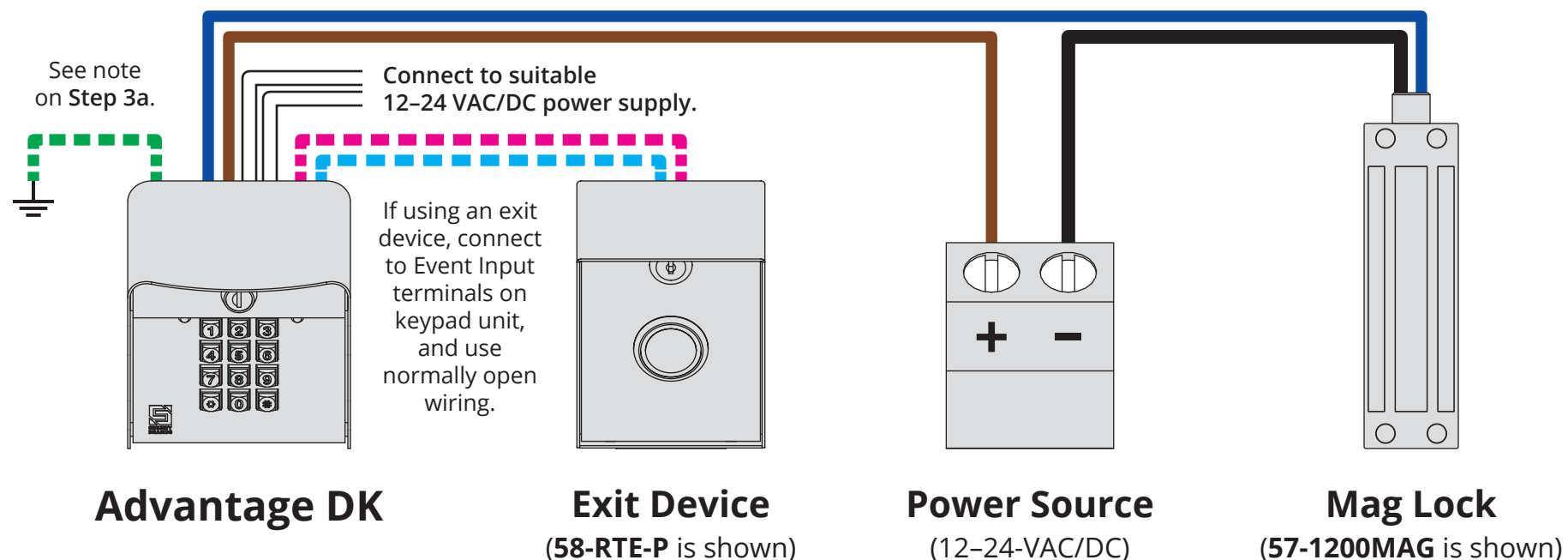



**4** Add Access Code(s) to Relay A.  
(To add multiple codes, enter each of them before pressing pound key)

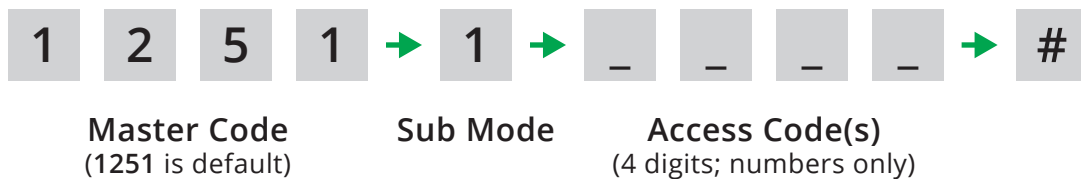

**NOTE:** The Master Code is for programming only and will not trigger the relay. The green arrow indicates a "good" tone on the keypad. An incorrect entry will sound a "bad" tone.

**5** Make sure gate path is clear; then enter access code on keypad and confirm gate opens.



### INSTALLATION COMPLETE!

Your system is ready to use.

## A1 Additional Programming

**Delete Code(s)**  
(To delete multiple codes, enter each of them before pressing pound key)

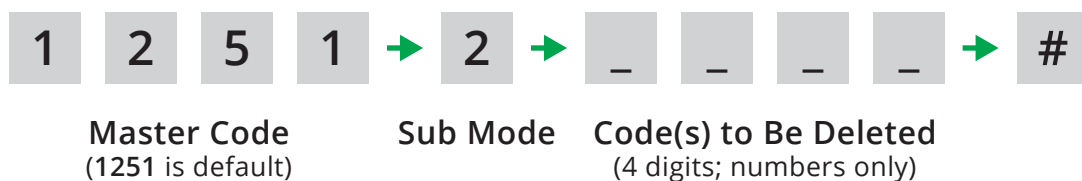

### Change Master Code



### Set Sleep Code

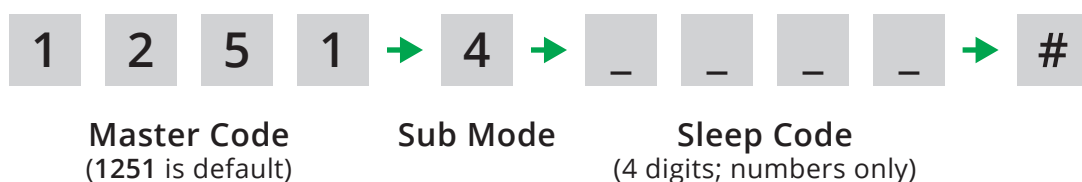

**NOTE:** Green arrow indicates "good" tone on keypad. Always wait for good tone before moving on.

## Things to Know

### Status LEDs

The yellow LED comes on when the unit is in Programming Mode. The red LED comes on when a relay is active.

### The Star Key (\*)

The star key deletes your current entry. If you happen to make a mistake keying in a code, simply press the star key to delete the entire entry and start over.

### The Pound Key (#)

The pound key is good for one thing and one thing only: exiting Programming Mode. Whenever you're in Programming Mode, simply press the pound key to get out.

### Reset Procedures

If for some reason the Master Code is forgotten or the unit needs to be reset to factory defaults, two reset procedures are available: **Master Reset** and **Unit Reset**.

These procedures can be found on **Page 5** of this guide.

## Programming Sub Modes

- 1 Add Access Code(s) to Relay A
- 2 Delete Code(s)
- 3 Change Master Code
- 4 Set Sleep Code
- 5 Set Latch Code on Relay A
- 6 Set Relay Output Time
- 7 Add Access Code(s) to Relay B
- 8 Configure "Three Strikes, You're Out"
- 9 Configure Event Input
- 0 Delete All Codes

**A2** Additional Programming (continued)

**Set Latch Code on Relay A**

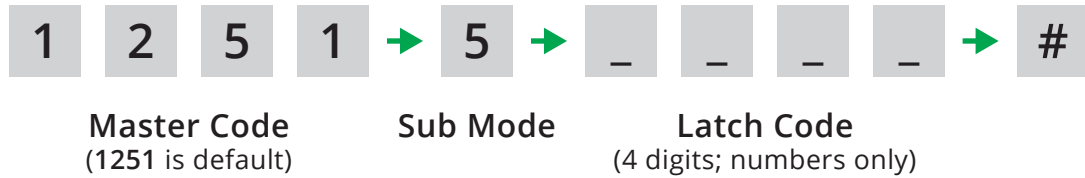

**Set Relay Output Time**

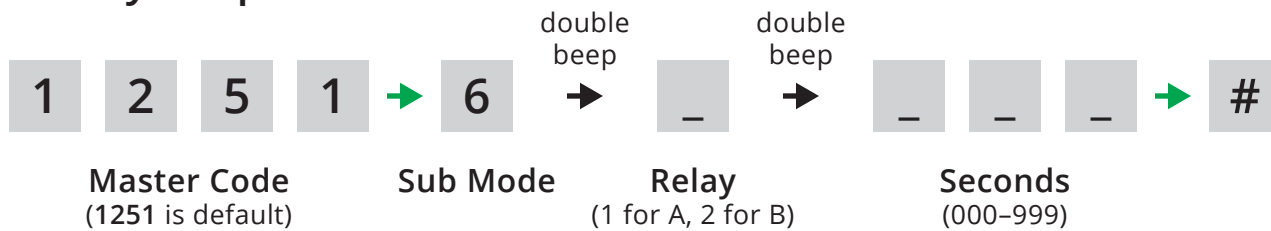

**Add Access Code(s) to Relay B**

(To add multiple codes, enter each of them before pressing pound key)

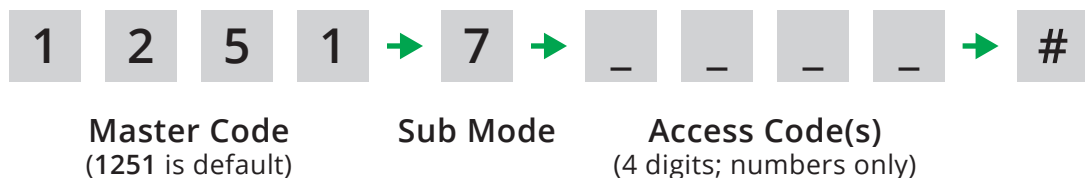

**Configure “Three Strikes, You’re Out”**

(This feature is a deterrent that activates when an incorrect code is entered three times in a row. When enabled and this event occurs, the unit will go into a period of lockdown for 90 seconds and will sound an alarm and flash the status LEDs for 30 seconds.)

**Check Status**

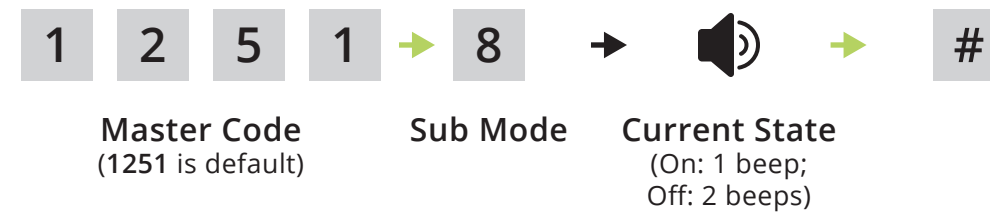

**Toggle On or Off**

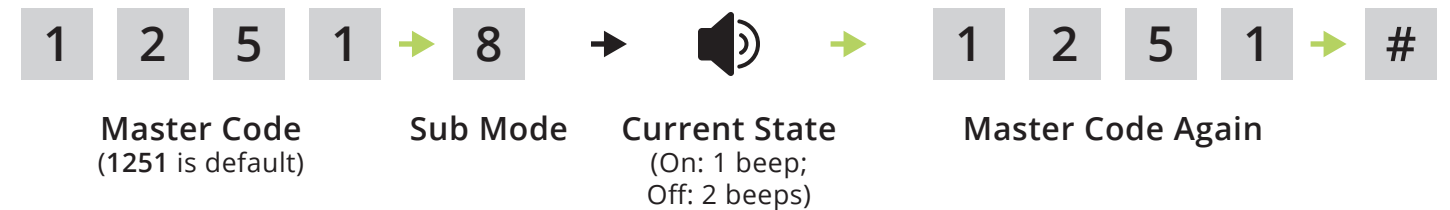

**Delete All Codes (Cannot Be Undone)**

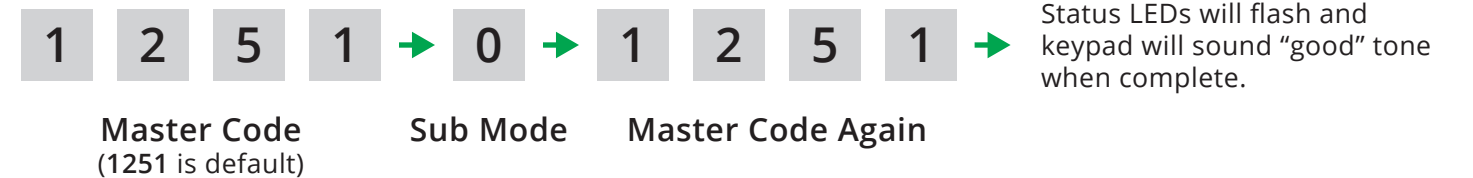

**NOTE:** Green arrow indicates “good” tone on keypad. Always wait for good tone before moving on.

## A3 Additional Programming (continued)

### Configure Event Input

(Allows an external device to affect keypad operation or trigger a relay)

**Modes** (Actions will occur when input is received from external device)

#### Mode 1 - Remote Inactive Mode

Disables all Relay A codes when input is received from external device

#### Mode 2 - Arming Circuit Mode

Turns on keypad unit when input is received from external device

#### Mode 3 - Remote Open Mode

Triggers either Relay A or Relay B when input is received from external device

#### Mode 0 - Event Input Disabled

### Set Mode 1, Mode 2, Disable, or Check Current Mode

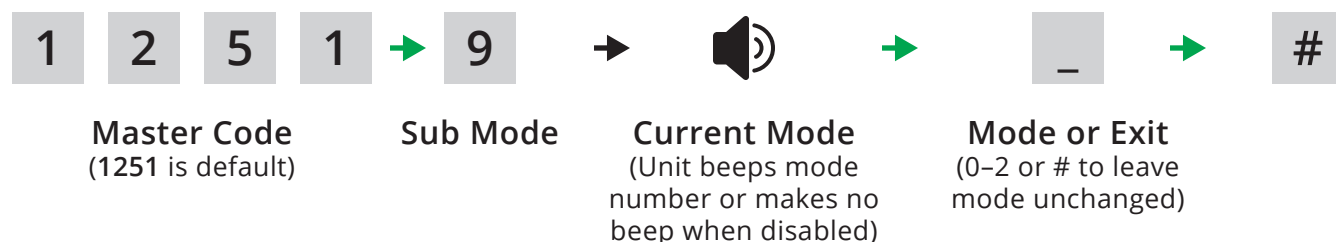

### Set Mode 3

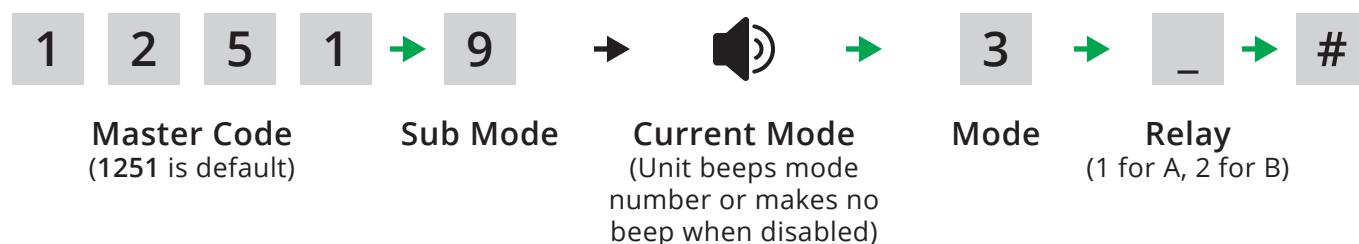

**NOTE:** Green arrow indicates "good" tone on keypad. Always wait for good tone before moving on.

## B Reset Procedures

**NOTE:** If an error is made during these procedures, an "error" tone will sound and you must start again from the beginning.

### Master Reset

(Used if the Master Code is unknown, if the Latch Code is unknown and the unit is in Latch Mode, or if the Sleep Code is unknown and the unit is in Sleep Mode. All other codes will be retained after completing this procedure.)

**Step 1 - Open faceplate on unit.**

**Step 2 - Disconnect power.**

Gently unhook wire harness connector from circuit board and not orientation of connector.

**Step 3 - Press and hold Reset Button; reconnect power; then release Reset Button.**

Gently reattach wire harness connector to circuit board. Unit will sound one (1) tone. Release Reset Button after you hear tone.

**Step 4 - Press Star key (\*) on keypad three (3) times.**

**Step 5 - Close faceplate on unit.**

The Master Code is now reset to default (1251).

### Unit Reset

(Used to reset unit to factory default settings. All codes are erased in this procedure.)

**CAUTION: FOLLOWING THIS PROCEDURE WILL DELETE ALL CODES!**

**Step 1 - Open faceplate on unit.**

**Step 2 - Disconnect power.**

Gently unhook wire harness connector from circuit board and not orientation of connector.

**Step 3 - Press and hold Reset Button; reconnect power; then release Reset Button.**

Gently reattach wire harness connector to circuit board. Unit will sound one (1) tone. Release Reset Button after you hear tone.

**Step 4 - Enter Pound (#) Star (\*) Pound (#) on keypad.** (Unit will sound "good" tone.)

**Step 5 - Enter 1251 (Master Code) on keypad.** (Unit will flash status LEDs and beep.)

**Step 6 - While unit is beeping, disconnect and reconnect power.**

Do this the same way as before. Unit will then go through power-up procedure.

**Step 7 - Close faceplate on unit.**

The unit is now reset to factory default settings.

