

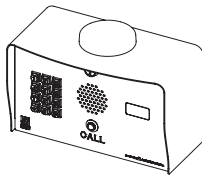



1 Unpack box and make sure you have all items shown here.



Ascent Unit



12-V AC/DC Adapter



Key



Carriage Bolt
(4x)



Hex Nut
(4x)

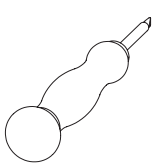

Screwdriver

2 Unlock and open unit faceplate for mounting, wiring, and setup.

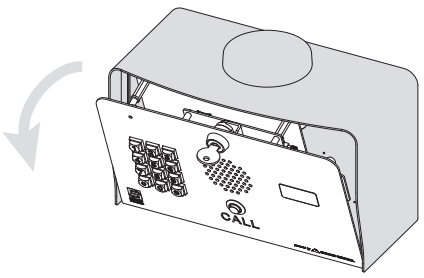

IMPORTANT

This Ascent unit **WILL NOT WORK** until the activation process is **COMPLETE!**

See the included **Activation Guide** to get this unit activated.

If you need help or have any questions, please contact **Summit Control** at **(972) 474-6422**.

WARNING

AUTOMATIC GATES CAN CAUSE SERIOUS INJURY OR DEATH!

ALWAYS CHECK THAT THE GATE PATH IS CLEAR BEFORE OPERATING!

REVERSING OR OTHER SAFETY DEVICES SHOULD ALWAYS BE USED!

3 Mount unit to pedestal using included mounting hardware. (This step may be completed later.)

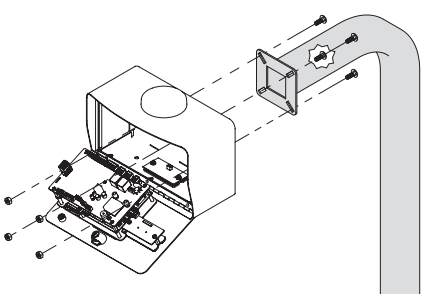

IMPORTANT

We recommend mounting the unit on a gooseneck pedestal using the included mounting hardware.

If using alternate mounting, the **4G LTE Antenna Extension Kit (Model 16-ANTX-1)** should be purchased and installed.

Failure to do so may result in NO SIGNAL!

CAUTION

Use all four carriage bolts when mounting the unit to a pedestal.

Leave the "hockey puck" antenna in place even if using an antenna extension.

Seal all openings created in the enclosure.

Failure to follow these instructions can damage the unit!

STOP

This is a cellular accessory for a gate or door. An uninterrupted cellular connection **CANNOT BE GUARANTEED!**

An emergency egress or primary entry mechanism **SHOULD ALWAYS BE USED!** (transmitter, fire box, mechanical release)

Consult with your dealer, distributor, and/or system designer for more information.

What's what?

All important components labeled

Unit shown with faceplate fully open. Internal wiring not shown for clarity.

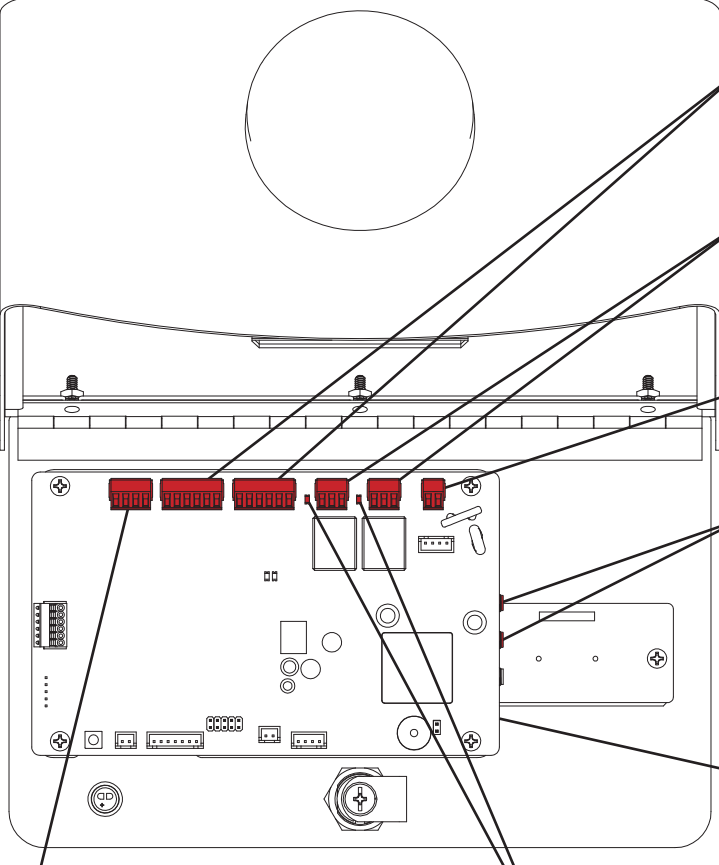

- Wiegand Terminals**
For wiring to Wiegand devices. See Page 2.
- Relay Terminals**
For wiring to gate operator or door opener. See Page 2.
- Power Terminals**
For wiring to included power supply. See Page 2.
- Cellular Antenna Jacks**
Cellular antenna extension kits connect here
- SIM Card**
Located on left side of lower circuit board. Press in gently to eject.
- Digital Input Terminals**
For connecting accessory devices. Scan QR code on next page for wiring instructions.
- Relay Status LEDs**
Relay is active when lit

NEED HELP

Call (972) 474-6422
 Email support@summitcontrol.com
 We are available **Mon-Fri / 8am-5pm Central**

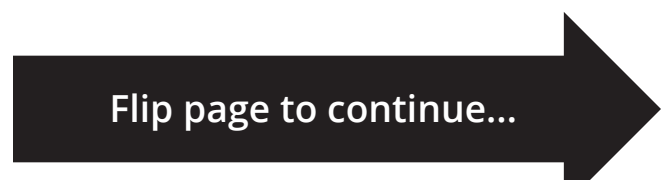

4 Connect wires

Feed wires through back of unit, and connect as shown using included screwdriver.

Consult gate/door opener manual for exact connections. Terminals vary widely across manufacturers and models.

Additional wiring diagrams can be found below and online.

We recommend using 18-gauge stranded wire for all connections.

CAUTION

When connecting the power supply, remember to connect positive to positive and negative to negative to avoid damage.

Reversing polarity can damage the unit and void the warranty!

Ascent terminals can be unplugged to make wire connections easier.

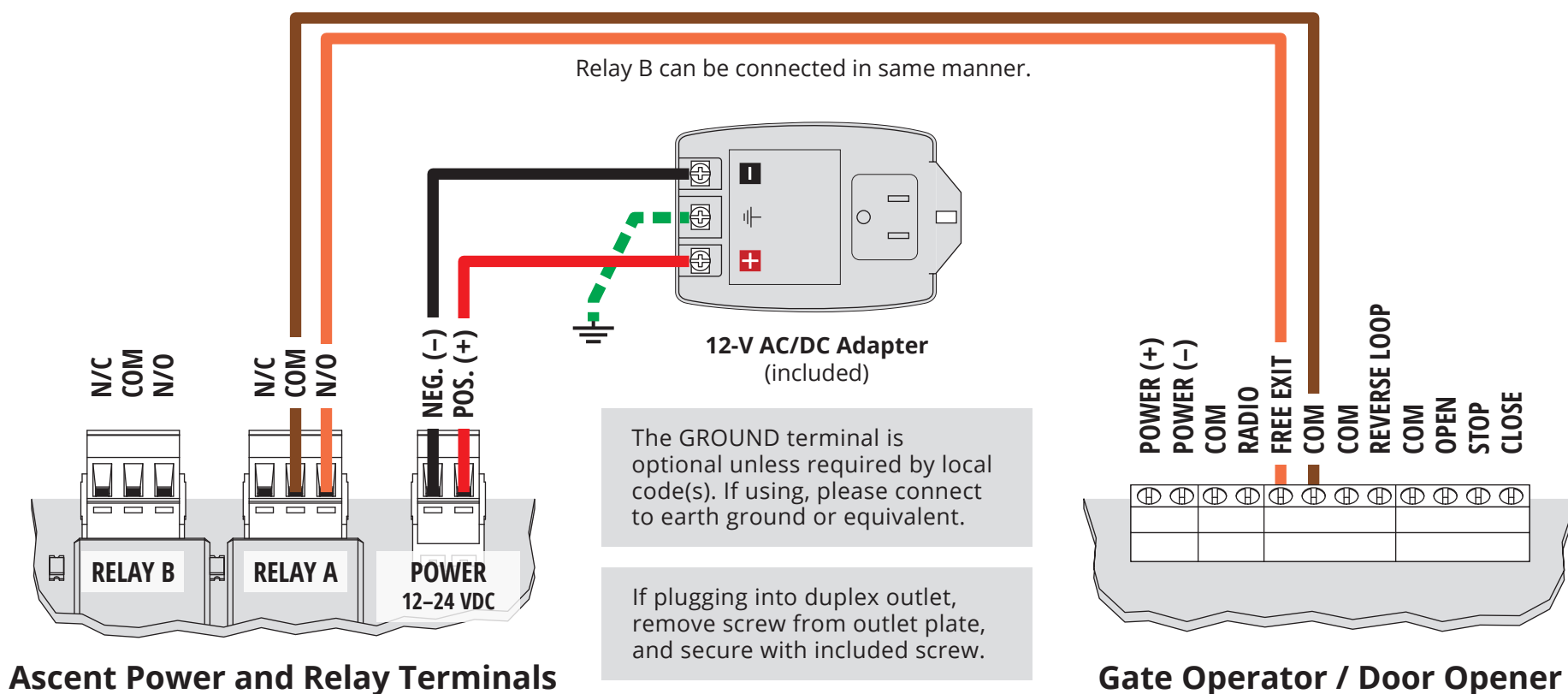

STOP

Before going forward, double check all wiring and make sure the unit has power!

A wiring diagram for connecting to Wiegand devices can be found below.

For connecting accessories not mentioned, please scan the QR code on this page.

Make sure the gate path is clear before completing Step 5!

5 Key in temporary code 2012 on keypad and confirm gate opens. If it does, close and lock unit faceplate.

2 0 1 2

Adding and deleting codes is done through Summit Control and **NOT** from keypad on unit!

INSTALLATION COMPLETE!

Now follow the **Activation Guide** to create an account and begin using Ascent.

A Wiegand Device

Feed wires through back of unit, and connect as shown using included screwdriver.

These terminals are used to connect a Wiegand device such as a card reader or Wiegand keypad.

Either set of Wiegand terminals can be used for wiring and then configured in Summit Control.

CAUTION

Disconnect power to the Ascent unit before connecting Wiegand devices.

Failure to disconnect power can damage the unit!

Need More?

Use the QR code below to get access to more resources, including how-to videos and additional wiring diagrams for connecting accessory devices.



Ascent terminals can be unplugged to make wire connections easier.

