





1 Unpack box and make sure you have all items shown here.



Fire Access Box



Key

2 Open faceplate and mount to surface of pedestal (screws not included), and then carefully drill pass-through hole.

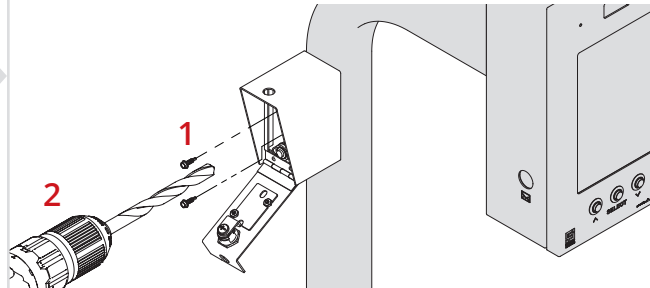

! IMPORTANT !

If using a Knox key switch, proceed to **Step A3** on this page.

If using a Knox (or other) padlock, proceed to **Step B3** on the next page.

A3 Remove key switch cover plate by first removing both hex nuts and then removing cover plate.

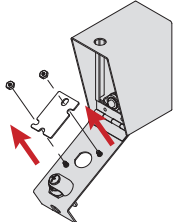

A4 Install Knox key switch (not included) and connect wires per manufacturer's instructions.

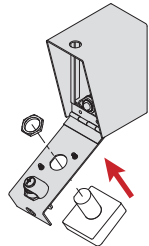

Contact the local fire department for a Knox key switch.

A5 Lock unit and remove key.





INSTALLATION COMPLETE!
Your system is ready to use.

! WARNING !

AUTOMATIC GATES CAN CAUSE SERIOUS INJURY OR DEATH!

ALWAYS CHECK THAT THE GATE PATH IS CLEAR BEFORE OPERATING!

REVERSING OR OTHER SAFETY DEVICES SHOULD ALWAYS BE USED!

INSTALL GUIDE | FIRE ACCESS BOX

Model 15-021

B3

Make wire connections.

Connect blue and brown wires from push button on fire access box as shown.

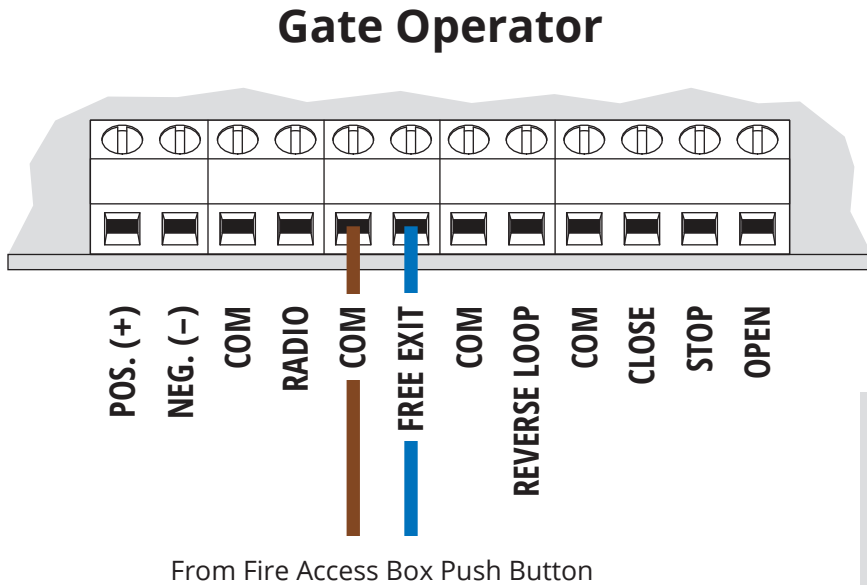

Consult gate operator or door opener manual for exact connections. Terminals vary widely across manufacturers and models.

B4

With faceplate open, turn key 180° so that cam faces downward (as shown), and then remove key.

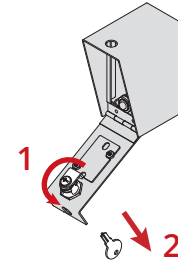

B5

Close faceplate and secure Knox (or other) padlock.

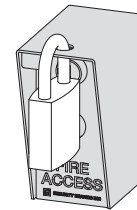

Contact the local fire department for a Knox padlock.



INSTALLATION COMPLETE!

Your system is ready to use.

NEED HELP

Call (972) 474-6390

Email techsupport@securitybrandsinc.com

We are available **Mon-Fri / 8am-5pm Central**



SECURITY BRANDS INC™

your *partner* in access control