

1 Carefully unpack box.

2 Make sure you have all items shown here. (Screwdriver not shown)

RTE Unit

9-V Battery

Key Switch Keys

Lock Key

Carriage Bolt
(x4)

Hex Nut
(x4)

Hole Plug

Adhesive
Mounting Pad

What's what?

Important components labeled

You **MUST** have the **Ridge Transceiver (14-REC20)** for this RTE unit to work. It is bundled with the Ridge 2.0 (14-500), Ridge RTE (14-RTE433), and can be purchased separately as well.

- Lock**
For securing interior of RTE unit
- Exit Button**
Triggers gate/door to open
- Key Switch**
For enabling and disabling unit
(Unit is disabled as shown)

RTE Unit Front Panel (Front)

- Reset Button**
For pairing RTE unit with transceiver
- 9-V Battery**
Must be installed before use

RTE Unit Front Panel (Back)

Internal wiring not shown for clarity.

- Connection Terminals**
For wiring to compatible AC/DC power source and gate operator or door opener
- Power LED**
Indicates whether or not unit has power
- Relay Status LED**
Indicates whether relay is active or inactive
(Relay is active when lit)
- Programming Button**
For pairing transceiver with RTE unit
- Programming LED**
Indicates status of pairing process

Transceiver (Not Included)

Shown with cover removed.
Internal wiring not shown for clarity.

3 Unlock and remove front panel of RTE unit; then using included carriage bolts and hex nuts, attach unit to pedestal as shown.

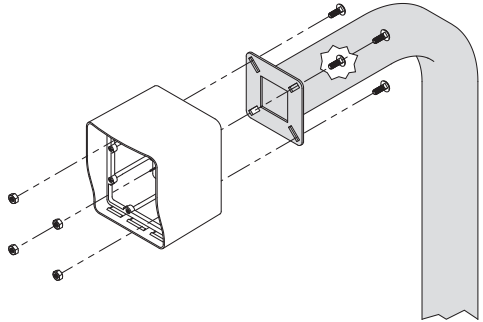

4 Using Tek screws, zip ties, or included adhesive mounting pad, attach transceiver to inside wall or another surface of gate operator.

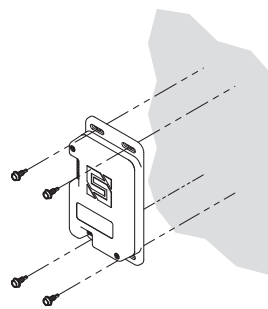

CAUTION!

The transceiver is not weatherproof and must be mounted inside a weatherproof enclosure. Internal components can be damaged if exposed to the elements.

Failure to comply will VOID WARRANTY.

WARNING!

AUTOMATIC GATES CAN CAUSE SERIOUS INJURY OR DEATH!

ALWAYS CHECK that the **GATE PATH IS CLEAR BEFORE OPERATING!**

REVERSING or other **SAFETY DEVICES SHOULD ALWAYS BE USED!**

5a Connect transceiver Gate Operator Timer-to-Close OFF

Ridge Transceiver

12-24 VAC/DC POWER RELAY A

Gate Operator / Door Opener

12-24 VAC/DC POWER

OR

12-24-VAC/DC Power Source (Not Included)

Consult gate operator or door opener manual for exact connections.
Terminals vary widely across manufacturers and models.

5b Connect transceiver Gate Operator Timer-to-Close ON

Ridge Transceiver

12-24 VAC/DC POWER RELAY A

Gate Operator / Door Opener

12-24 VAC/DC POWER

OR

12-24-VAC/DC Power Source (Not Included)

Consult gate operator or door opener manual for exact connections.
Terminals vary widely across manufacturers and models.

CAUTION!

A closing gate can cause injury to persons or damage to property.

ALWAYS USE SAFETY DEVICES!

6a Remove transceiver cover; then hold down Programming button on circuit board for 3 seconds and let go.

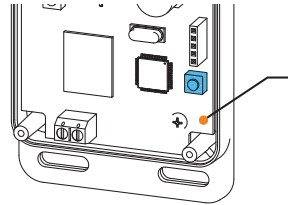

LED will light solid orange

6b Remove RTE unit front panel; then hold down Reset button on circuit board for 5 seconds and let go.
(Make sure battery is connected)

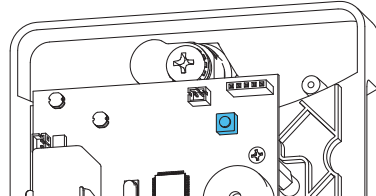

6c While pairing, RTE unit will beep momentarily. Once transceiver LED goes out, pairing is complete.

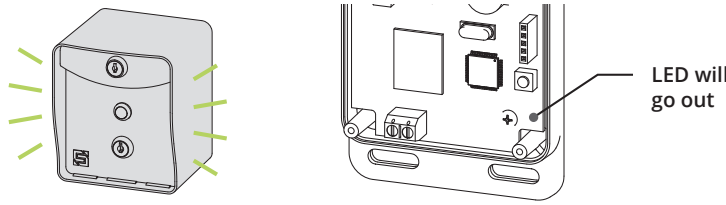

LED will go out

7 Make sure gate/door path is clear; then press exit button on RTE unit and confirm gate/door opens.
(If nothing happens, repeat Step 6)





INSTALLATION COMPLETE!

Your system is ready to use.

A The RTE unit can be disabled and re-enabled at any time by taking the key switch keys and using the key switch located below the exit button.

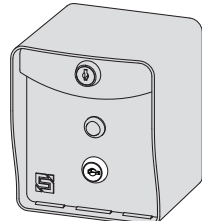

Unit Enabled
(exit button active)

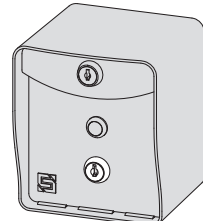

Unit Disabled
(exit button inactive)

B Unit Reset Procedure

This procedure is used to reset unit to factory default settings.

- Step 1 - Remove front panel of RTE unit.**
- Step 2 - Disconnect battery.**
- Step 3 - Press and hold Reset Button; reconnect battery; then release Reset Button.**
Unit will sound one (1) tone. Release Reset Button after you hear tone.
- Step 4 - Press and release Reset Button; then reattach front panel onto RTE unit.**

The unit is now reset to factory default settings.

