





1 Unpack box and make sure you have all items shown here. (Mounting screws and wall anchors not shown.)



Ridge ResKey Unit



AAA Battery
(2x)

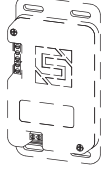

Receiver
(Security Brands 14-REC20 or 14-REC300 not included)

2 Remove single screw from bottom of unit and remove unit from mounting plate, pulling away from bottom end.

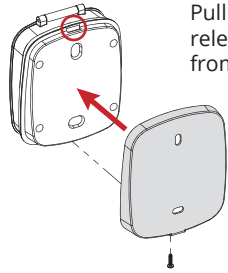

Pull away and down on unit to release mounting plate hook from unit groove (circled).

3 Remove screws from back of unit housing and carefully remove back cover to get access to battery holders.

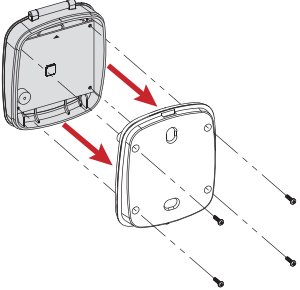

4 Hold circuit board in place and insert batteries into battery holders, making sure to place in correct orientation.

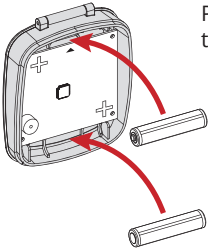

Place unit on a sturdy surface to make this step easier.

5 Replace back cover of unit and secure with screws.

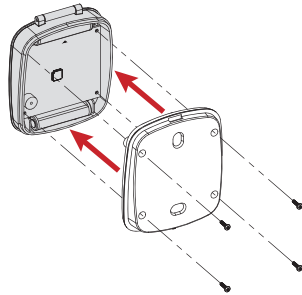

⚠ WARNING ⚠

AUTOMATIC GATES AND DOORS CAN CAUSE SERIOUS INJURY OR DEATH!

ALWAYS CHECK THAT THE GATE/DOOR PATH IS CLEAR BEFORE OPERATING!

REVERSING OR OTHER SAFETY DEVICES SHOULD ALWAYS BE USED!

6 Install mounting plate where desired using included hardware or other. (Can be done after programming.)

⚠ IMPORTANT!

This unit is IP44-rated and has some protection from the elements, but it should be mounted in a covered location.

Make sure to mount the unit away from metal objects and anything that will interfere with or block RF transmission.

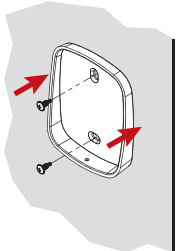

7 Attach unit and secure with screw. (Can be done after programming.)

Slip mounting plate hook (circled) into unit groove before pressing unit into place.

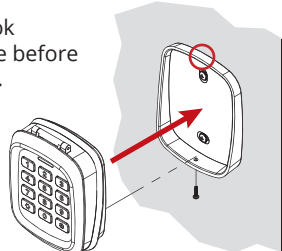

A 433-MHz Programming

(For the Ridge 2.0 Transceiver **14-REC20** only)

Pair Keypad Unit with Ridge 2.0 Receiver (14-REC20)

On Ridge 2.0 Transceiver, press and hold programming button for 3 seconds and let go. LED will light. Perform procedure below, and LED will go out if pairing is successful.

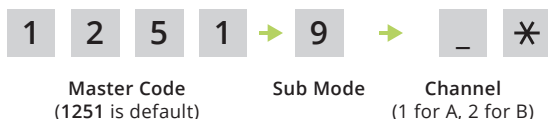

Add 433-MHz Access Code



Delete 433-MHz Access Code

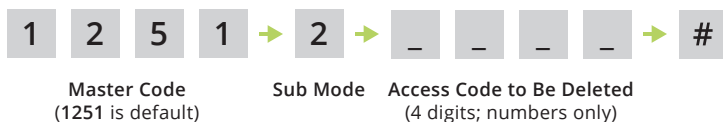

Change 433-MHz Master Code

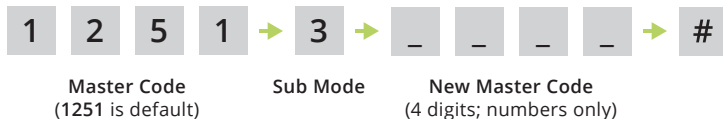

Add 433-MHz Limited-Use Code (Channel A Only)



Delete All 433-MHz Codes



B 300-MHz Programming

(For 300-MHz receivers including the Receiver 300 **14-REC300**)

IMPORTANT! For security reasons we recommend using custom DIP switch positions.

Add 300-MHz Access Code



Access Code to Be Added (4 digits; numbers only)

Delete 300-MHz Access Code

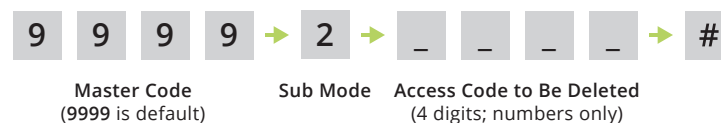

Change 300-MHz Master Code



Delete All 300-MHz Codes



Additional information can be found at securitybrandsinc.com/ridge/

NEED HELP

Call (972) 474-6390

Email techsupport@securitybrandsinc.com

We are available **Mon-Fri / 8am-5pm Central**



SECURITY BRANDS INC
your *partner* in access control