

ASCENT M³



16-M3 CELLULAR MULTI-TENANT ENTRY SYSTEM WITH 8-INCH TOUCHSCREEN

FEATURES

- Full cellular connectivity
- Vibrant full-color 8-inch LCD touchscreen
- HD video calling with IR for low light
- Time/use-limited QR-code quick access
- Control up to 2 gates/doors
- 2 Wiegand inputs
- Up to 5,000 app, text, and voice users*
- Up to 5,000 keypad codes*
- Rollover calling—up to 3 phone numbers
- Broadcast calling—up to 10 phone numbers
- Push and/or email event and status notifications
- Cloud-based access control management
- LED downlight and LED-backlit buttons



* Maximum number is dependent on plan.



powered by  **SUMMIT CONTROL**
SIERRA

GET THE SUMMIT CONTROL SIERRA APP



VERSATILE AND CONVENIENT

Manage access control of a property from anywhere there's an internet connection.

AN ASCENT WITH A VIEW

Crisp HD video with IR gives residents clear visual ID when their guests arrive to a property, even in low light.

POWERFULLY EXPANDABLE

Network multiple Ascent units together and manage multiple entries via Summit Control.

NO-NONSENSE INTERFACE

Navigating the on-screen directory couldn't be any easier for guests—quickly filter, find, and tap your party on the screen to call.



SPECIFICATIONS

PHYSICAL

Dimensions 12.93"(H) x 6.75"(W) x 4.36"(D)
 Shipping Weight 14 lbs.

ELECTRICAL

Input 12-24 VAC/DC
 12-VDC power supply included (PS-12DC2)
 Current Draw less than 460 mA @ 12 VDC
 less than 210 mA @ 24 VDC
 with relays latched and LED components on

RELAY

Contact Rating 10 A @ 120 VAC / 24 VDC
 Max Switching Voltage 250 VAC / 30 VDC
 Max Switching Current 15 A
 Max Switching Power 240 W / 2,770 VA

COMMUNICATION







Cellular Network 4G LTE

ENVIRONMENTAL

Operating Temperature -15 to 158 °F

CONTROL IT YOUR WAY

2nd
DOOR

-  APP
-  TEXT
-  VOICE
-  KEYPAD*
-  DIRECTORY
-  WIEGAND DEVICES
-  QR CODE

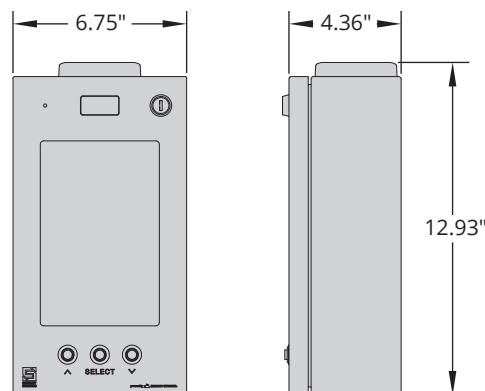

⚠ Actual voltage should be no more than 10% beyond specified range. Use of the included 12-VDC power supply is recommended.

Hole pattern on back for pedestal mounting is spaced at 3.063" with pilot holes for alternate mounting at 2.5".

GET STARTED NOW!

PAY JUST ONE BILL!*

Unit includes a SIM card preinstalled and ready for activation.

We do ALL the legwork for you!



SUMMIT CONTROL

visit summitcontrol.com



* Because keypad codes are managed via Summit Control, they cannot be added or deleted without an active service plan.

† Monthly bill covers cost of SIM card, actions gateway, servers, maintenance, development, mobile app, admin portal, and tech support.

For more information, visit us online:
securitybrandsinc.com



SECURITY BRANDS INC™