

ASCENT M⁸



16-M8 CELLULAR MULTI-TENANT ENTRY SYSTEM WITH 8-INCH TOUCHSCREEN

FEATURES

- Full cellular with automatic network selection
- Vibrant full-color 8-inch LCD touchscreen
- HD video calling with IR for low light
- Time/use-limited QR-code quick access
- Control up to 4 gates/doors
- 4 Wiegand inputs
- Up to 5,000 app, text, and voice users*
- Up to 5,000 keypad codes*
- Rollover calling—up to 3 phone numbers
- Push and/or email event and status notifications
- Cloud-based access control management
- LED downlight and LED-backlit buttons



* Maximum number is dependent on plan.



powered by  **SUMMIT CONTROL**
SIERRA

GET THE SUMMIT CONTROL SIERRA APP



VERSATILE AND CONVENIENT

Manage access control of a property from anywhere there's an internet connection.

AN ASCENT WITH A VIEW

Crisp HD video with IR gives residents clear visual ID when their guests arrive to a property, even in low light.

POWERFULLY EXPANDABLE

Network multiple Ascent units together and manage multiple entries via Summit Control.

NO-NONSENSE INTERFACE

Navigating the on-screen directory couldn't be any easier for guests—quickly filter, find, and tap your party on the screen to call.









SPECIFICATIONS

PHYSICAL	
Dimensions	16.05"(H) x 10.50"(W) x 4.75"(D)
Shipping Weight	18 lbs.
ELECTRICAL	
Input	24 VDC 24-VDC power supply included (PS-24DC3)
Current Draw	dependent on user settings Unit requires constant power source and is not recommended for solar applications
RELAY	
Contact Rating	10 A @ 120 VAC / 24 VDC
Max Switching Voltage	250 VAC / 30 VDC
Max Switching Current	15 A
Max Switching Power	240 W / 2,770 VA
COMMUNICATION	
Cellular Network	4G LTE
ENVIRONMENTAL	
Operating Temperature	-15 to 158 °F

CONTROL IT YOUR WAY

4
DOOR

-  APP
-  TEXT
-  VOICE
-  KEYPAD*
-  DIRECTORY
-  WIEGAND DEVICES
-  QR CODE

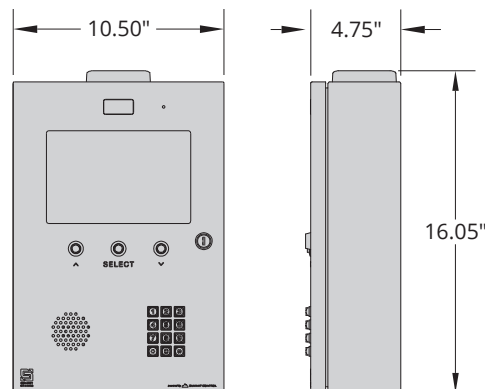

▲ Actual voltage should be no more than 10% beyond specified range. Use of the included 24-VDC power supply is recommended.

Hole pattern on back for pedestal mounting is spaced at 3.063" with pilot holes for alternate mounting at 2.5".

GET STARTED NOW!

PAY JUST ONE BILL!*

Unit includes a SIM card preinstalled and ready for activation.

We do ALL the legwork for you!



SUMMIT CONTROL

visit summitcontrol.com



* Because keypad codes are managed via Summit Control, they cannot be added or deleted without an active service plan.

† Monthly bill covers cost of SIM card, actions gateway, servers, maintenance, development, mobile app, admin portal, and tech support.

For more information, visit us online:
securitybrandsinc.com



SECURITY BRANDS INC™